

MCW-570

Automatic Flood Prevention System



Installation Instructions

1. INTRODUCTION

1.1 Purpose and Use

The MCW-570 is a fully supervised flood prevention system. It is triggered by up to 10 flood detectors that are located inside the protected site where presence of water flooding or leakage is probable.

Upon cold/hot water flood detection, the system automatically shuts off the water supply to the protected site (by means of 1 or 2 cold/hot electro-mechanical ball valves) and provides valve status indication, on the Control Unit and on the water valve(s).

Turning ON the water supply, after repairing the water leak, is performed by pressing the OPEN button - see figure 1.

Manual turning OFF the electro-mechanical ball valve is also possible, by pressing the CLOSE button - see figure 1.

In case of power failure, it is possible, on some models, to manually open/close the valve (see Fig. 8).

Optional - In addition to flood preventing, the system can also send ALARM, TROUBLE and LOW BATTERY signals to a remote control unit for remote indication (see figure 7).

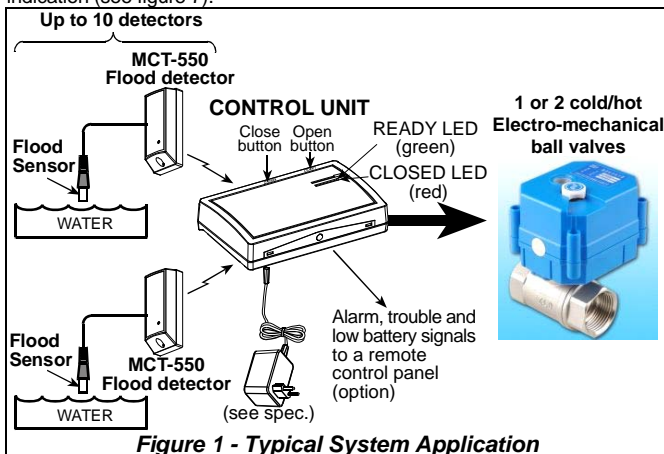

Figure 1 - Typical System Application

2. SPECIFICATIONS

2.1 Control Unit Specifications

RF SECTION

Front-End Module: Super-regenerative UHF receiver.

Operating Frequency (MHz): 315, 433, 868.95 or other frequency according to local requirements in country of use.

DATA PROCESSING SECTION

ID codes: Over 16,000,000 possible 24-bit combinations

Total Message Length: 36 bits

ID Learning Capacity: Up to 10 different ID codes

ELECTRICAL DATA

Input Voltage (according to the electronic module type and cold water valve diameter):

Electronic Module Cat. #	Valve diameter		Input Voltage
	Cold water	Hot water	
E-200856	3/4" or 1"	1/2"	9V / 0.35A Min.
E-202355	1-1/4"	-	12VAC / 1A Min.

Current Drain @9VAC: Standby - 30 mA. During 2 valves closing/opening process only - up to 200 mA.

Relay Outputs: Form 1C (N.C. and N.O.)

Relay Contact Ratings: 1A resistive, 30 VDC or AC.

Status Outputs: 2, up to 100 mA each, open-collector type

ELECTRO-MECHANICAL BALL VALVE

Max water pressure: 8 Bar

Valve Diameter for Hot Water: 1/2"

Valve Diameter for Cold Water: 3/4", 1" or 1-1/4".

Valve closing Time: 5-11 seconds

PHYSICAL

Operating Temperatures: 0°C to 49°C (32°F to 120°F)

Control Unit Dimensions (HxWxD): 108x165x38 mm (4-1/4x6-1/2x1-1/2").

1.2 Kit Contents

The MCW-570 system includes the following (see figure 1):

- One Control Unit:** In case of flood, the Control Unit receives signal from up to 10 wireless water flood detectors, sends OFF command to the water electro-mechanical valve(s) and provides indication of the closed valve(s).
- One wireless flood detector MCT-550:** The flood detector transmits an alarm signal to the Control Unit upon flood detection.
- One cold water electro-mechanical ball valve:** The electro-mechanical ball valve is directly installed on pipe of central water supply. The valve automatically turns OFF the water supply in case of flood detection.
- One power transformer - 9VAC output.**

Note: The system is designed for use with water valves that are supplied by the system manufacturer only.

1.3 LEDs Operation

The Control Unit includes 2 main LED indicators (see Fig. 1), that function according to the following table:

Valve Status	Red LED	Green LED
Power-up	High frequency flashing	High frequency flashing
Opened (no flood)	Does not light	Lights
Closed	Lights	Lights
During opening / closing	High frequency flashing	Lights
Opened manually (override) by user although flood still exists	Low frequency flashing	Lights

The Control Unit includes 2 additional LED indicators (in the receiver module - see Fig. 6), that are visible only after removal of the Control Unit cover:

- Red **SIGNAL / MEMORY STATUS** LED - illuminates as long as the receiver receives signal from recognized flood detector. This LED is also used during the flood detectors "learning" process (described in par. 3.3).
- Yellow **MEMORY LOCATION STATUS** LED indicator - used during the "learning" process.

Weight: Control Unit - 217 g (7.6 oz.), 3/4" WATER VALVE - 345g (12 oz.), 1" WATER VALVE - 526g (18 oz.), 1-1/4" WATER VALVE 1.6Kg (3-1/2 Lb), AC ADAPTER - 200g (7 oz.).

Control Unit Color: Off white

COMPLIANCE WITH STANDARDS

EN13564-1, EN13564-2, EN60950, EN300220, EN301489

2.2 Flood Detector MCT-550 Specifications

TRANSMITTER

Frequency (MHz): 315, 433, 868.95 or other frequency according to local requirements in country of use

Transmitter's ID Code: 24-bit digital word, over 16 million combinations, pulse width modulation.

Overall Message Length: 36 bits

Message Repetition: One-shot transmission (default) or once every 3 minutes (selectable).

Supervision: Signaling at 60-minute intervals (U.S. version) or 15 minute interval (UK version), or according to the local standards.

Response to Tamper Event: Tamper report every 3 minutes (until the tamper switch is restored).

ELECTRICAL DATA

Power Source: 3V Lithium battery, Panasonic type CR-2 or equivalent.

Note: Dispose of used battery according to the manufacturer's instructions.

Nominal Battery Capacity: 750 mAh

Current Drain: 6µA STBY, 17mA average in operation (including LED).

Battery Life with LED on: 3 years (for typical use)

Battery Supervision: Automatic reporting of battery condition data as part of any transmission.

ALARM REPORT:

Every 20 sec. for the first 3 minutes. Every 3 min. for the next 27 minutes.

Alarm stops reporting after 30 min., or if the detector goes into "alarm restore".

Length of Flood Sensor Cable: 3 meters (10 ft)

PHYSICAL DATA

Weight of Flood Sensor Cable: Approx. 60 gr.
Operating Temperature: 0°C to 49°C (32°F to 120°F).
Dimensions: 81 x 22 x 23.5 mm (3-3/16 x 7/8 x 15/16 in.).
Weight (including battery, without cable): 45 g (1.6 oz)
Standards: Meets FCC Part 15, Directive 1999/5/EC and EN 50131-1 Grade 2, Class II

This device complies with Part 15 of the FCC Rules and RSS 210 of Industry and Science Canada. Operation is subject to the following two conditions: (1) This device may not cause harmful interference, and (2) this device must accept any interference received, including interference that may cause undesired operation.

This device complies with the essential requirements and provisions of Directive 1999/5/EC of the European Parliament and of the Council of 9 March 1999 on radio and telecommunications terminal equipment.

3. FLOOD DETECTORS ENROLLING IN THE CONTROL UNIT MEMORY

Note: The system is supplied with 1 flood detector whose enrolling process was already performed by the manufacturer. If the system will include 1 flood detector only, proceed to chapter 4. If more detectors will be used, proceed to paragraph 3.1 to "teach" the system to identify the additional detectors.

3.1 Helpful Tips

A learning session is required to let the Control Unit learn the ID codes of individual wireless flood detectors that will control the electro-mechanical water valve.

The quickest way to conduct a learning session is on the work bench, where every required flood detector is within reach, and where you may observe the Control Unit indication LEDs.

3.2 Initial Steps

- A. Remove Control Unit cover (see figure 5 steps 1 & 2).
- B. Temporarily power up the Control Unit by using the supplied 9VAC adapter.
- C. Open the flood detector and insert battery (see figure 3).

3.3 Learning Flood Detector IDs

A single transmission (Flood alarm, Tamper or Restore) is required to enroll a flood detector's ID in the Control Unit memory.

For "teaching" flood detector IDs into the receiver memory, proceed as follows:

- A. Set the OPERATE / LEARN jumper (see Fig. 6) to LEARN as shown at the right. The yellow LED (see Fig. 6) will start flashing at a constant rate.



Description of Yellow LED (Memory Location) Indications

The flood detectors identification, in the receiver module memory, is divided into 10 locations, one per each flood detector ID. Memory locations may be selected in ascending order from 1 to 10, by clicking the receiver module tamper switch (see Fig. 6).

The yellow LED (see figure 6) indicates which memory location is selected. The information is conveyed by flashing sequences as demonstrated in the following chart:

No. of Clicks	Mem. Loc.	Flashing Sequence of the Yellow LED
One	1 st	☼ — ☼ — ☼
Two	2 nd	☼☼ — ☼☼ — ☼☼
Three	3 rd	☼☼☼ — ☼☼☼ — ☼☼☼
Four	4 th	☼☼☼☼ — ☼☼☼☼ — ☼☼☼☼
Five	5 th	☼☼☼☼☼ — ☼☼☼☼☼ — ☼☼☼☼☼
..... and so on, until the tenth click		

☼ = Flash; — = Pause

- B. Click the receiver tamper switch (see figure 6) the correct number of times (1 - 10) to select the desired memory location. Each click of the tamper switch advances to the next memory location according to the above table. The SIGNAL / MEMORY STATUS LED (red, see Fig. 6) will show the status of the selected location as follows:

Memory Status	Red LED Response
Location is free	LED Flashes
Location already contains an ID	LED Lights steadily

- C. If the memory status is free (as shown in the above table) initiate a transmission from the flood detector you wish to enroll in the selected location, by inserting battery into the flood detector or (if it's battery was already inserted) click the flood detector tamper switch (see figure 6).

Two kinds of response may be expected:

Red LED Response (Fig. 6)	Significance
Lights steadily	flood detector ID enrolled
Continues to flash	flood detector ID not enrolled

Note: You can not enroll a flood detector in a busy location.

- D. Repeat Steps B through C for all of the remaining flood detectors.
- E. **Caution:** During the next action be careful not to touch the DELETE button, otherwise the flood detector enrolling may be erased!

Quit the LEARN mode by setting the OPERATE / LEARN jumper back to OPERATE, as shown at the right.



CAUTION! While handling the jumper, take care not to touch the TOGGLE/PULSE jumper and DELETE button located close to the jumper. Verify that the TOGGLE/PULSE jumper is in PULSE position!

Note

If you leave the jumper in the LEARN position and no further learning activity takes place for 5 minutes, the LEARN mode will be automatically abandoned.

3.4 Clearing Flood Detector IDs

- A. Set the OPERATE/LEARN jumper to LEARN position. The internal yellow LED (see Fig. 6) will start flashing at a constant rate.
- B. Click the receiver tamper switch (see Fig. 6) the correct number of times (up to 10) to select the desired memory location (see Para. 3.3). The red LED (see Fig. 6) will show the status of the selected location as follows:

Status	Red LED Response
Memory location is free	LED Flashes
Memory location already contains an ID	LED lights steadily

- C. Click the DELETE pushbutton (see Fig. 6) once. The red LED (see Fig. 6) will respond as follows:

Red LED Response	Significance
Flashes at a constant rate	Success (ID deleted)
Continues to light steadily	Failure

- D. When done, quit the LEARN mode by setting the OPERATE/ LEARN jumper back to OPERATE.

3.5 What if the ID is Not Enrolled?

If the flood detector ID has not been accepted even though the memory location is free (the red LED continues to flash), try transmitting again. If the second attempt is unsuccessful, the flood detector in question may be faulty. Try enrolling another flood detector.

4. FLOOD DETECTOR AND FLOOD SENSOR INSTALLATION

4.1 Flood Sensor Installation

- a. locate the flood sensor on the wall, near the floor, according to the required height. The recommended height is 0-3 cm from the floor.
- b. Fasten the sensors' cable to the wall with 3 clamps. The first clamp should be very close to the sensor and the other 2 clamps as desired.

Note: To protect the cable from rats, it is recommended that the cable will be inside a plastic/iron tube.

4.2 MCT-550 Flood Detector Installation

The detector must be installed vertically (see figure 2) and fastened to the wall as high as possible, to improve the radio communication and prevent contact with water in case of flood. The installation process is shown in figure 3. Countersunk head screws should be used to prevent short circuit in printed circuit.

4.3 Connection of flood Sensor's cable to the Flood Detector

Connect the 2 sensor's wires to the AUX terminals of the MCT-560 flood detector (see figure 4). Either one of the wires may be connected to either terminal.

4.4 Detector Closure

Close the detector (refer to figure 3).

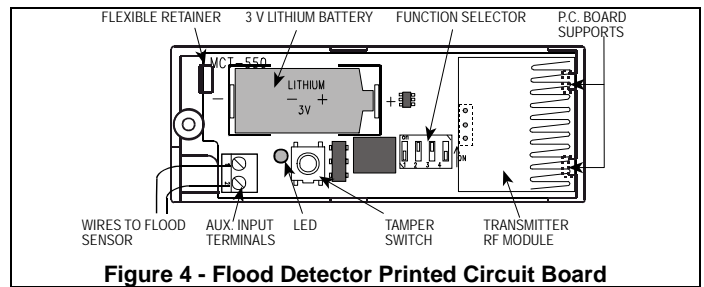

Figure 4 - Flood Detector Printed Circuit Board

Note regarding flood detector internal function selector

The flood detector has 4 internal switches (see Fig. 4): SW1 and SW2: These switches must be always in OFF (as set by the manufacturer).

SW3: If the detector will be used only with MCW-570, the position of this switch is not important. If the detector will be used with other systems (e.g. PowerMax), this switch enables (ON) or disables (OFF) event end reporting.

SW4: This switch is not used.

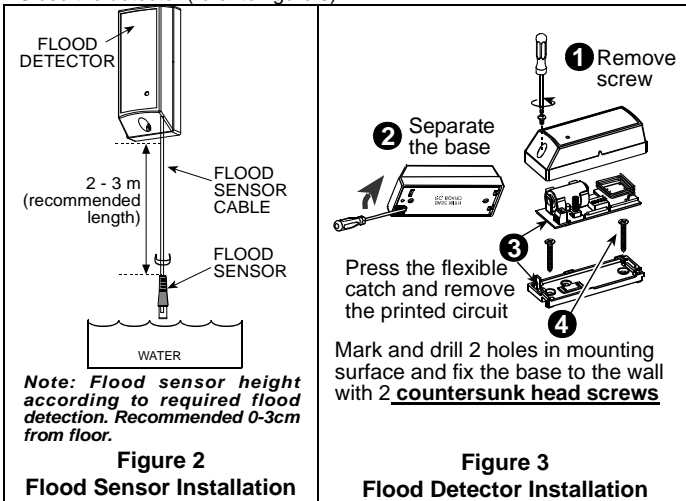

Note: Flood sensor height according to required flood detection. Recommended 0-3cm from floor.

Figure 2 Flood Sensor Installation

Figure 3 Flood Detector Installation

5. CONTROL UNIT INSTALLATION

5.1 Installation Location

The Control Unit, the flood detectors and the flood sensors are designed for installation inside the house only. The electro-mechanical water valve(s) should be installed on the site main water pipe.

5.2 Control Unit Installation (see figure 5)

Before installation, disconnect the power that was connected to the Control Unit during the enrolling process. Install the Control Unit as shown in figure 5, step 3. at height of at least 1.2m.

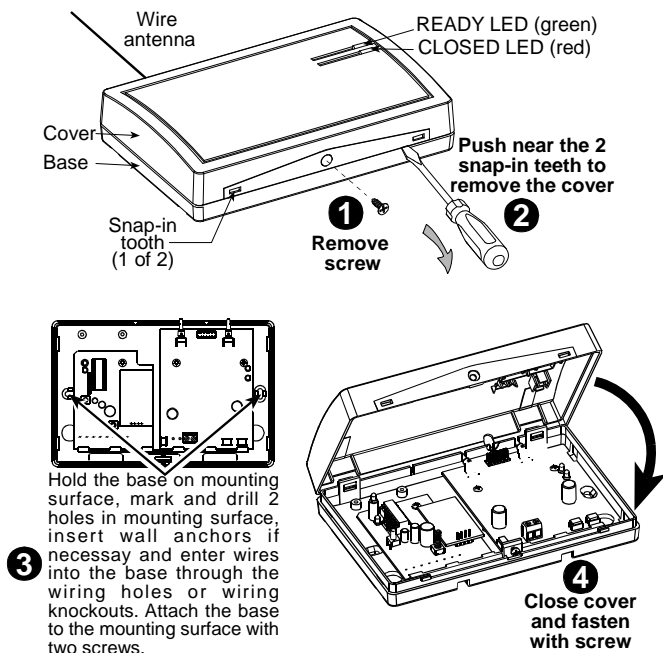

Figure 5 - Control Unit Mounting

5.3 Electro-mechanical Valve Installation

The water valve(s) must be installed by a qualified plumber in the site main water pipe.

Caution: The water valve(s) must be installed in addition to the existing water valve and not instead of it!

5.4 Power Connection

Connect the AC adaptor output (9VAC), that is supplied with the system, to the "PWR" terminals (see figure 6) - disregard the polarity.

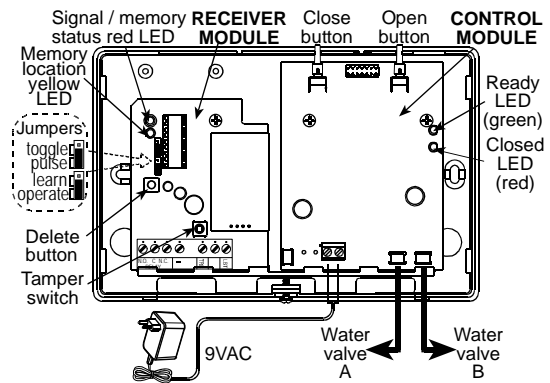

Figure 6 - Power Connection

5.5 One Water Valve Wiring

Connect the water valve cable to VALVE A or VALVE B connector (see Fig. 6).

5.6 Two Water Valves Wiring

Connect the cable of one valve to VALVE A connector and the cable of the other valve to VALVE B connector.

5.7 Remote control Panel Wiring (option)

Perform wiring as shown in figure 7.

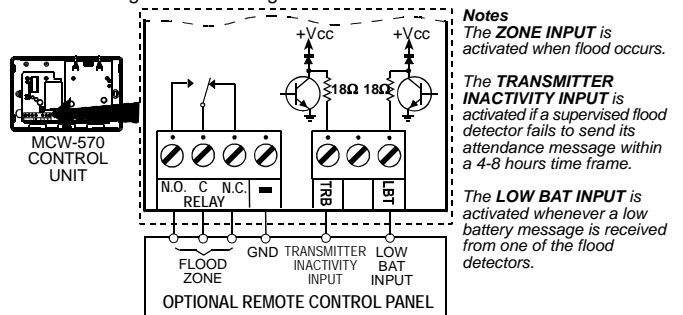

Figure 7 - Optional Remote Control Panel Wiring

5.8 Final Actions

Carefully close the front panel of the control panel, straighten the antenna wire and tighten the front panel with the screw (see figure 5).

6. SYSTEM FUNCTIONAL TEST

6.1 Valve(s) Manual Closing/Opening Test

A. Valve(s) Manual Closing Test

1. Press the CLOSE button (see figure 6).
2. Verify that the water valve(s) will be closed within few seconds, during which the red CLOSED LED (see figure 1) will flash. At the end of the closing process, the red CLOSED LED will constantly light and the valve(s) status indicator (see figure 8) should indicate "closed".

B. Valve(s) Manual Opening Test

1. Press the OPEN button (see Fig. 6).
2. Verify that the water valve(s) will be open within few seconds, during which the red CLOSED LED (see figure 1) will flash. At the end of the opening process, the red CLOSED LED will not light and the valve(s) status indicator (see figure 8) should indicate "open".

6.2 Valve(s) Automatic Closing Test

1. Thoroughly clean the flood detectors' sensors (see figure 1) with a rag and immerse them in water (for example, by using a glass of water) and verify that the water valve(s) will be closed within few seconds. During the closing process, the red CLOSED LED (see Fig. 1) will flash.

- At the end of the closing process, the red CLOSED LED will light steadily and the valve(s) status indicator (see Fig. 8) should indicate "closed".
2. Press the OPEN button (see Fig. 6), and verify that the water supply is restored.
 3. Perform steps 1 and 2 for every system's flood sensor.

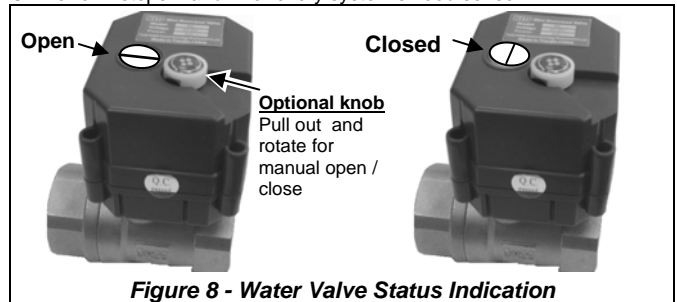

7. MAINTENANCE

System functional test **must be performed** every 3 months at least, including thorough cleaning of the flood sensors, according to section 6.

After the test turn the valve(s) to OPEN position (see par. 6.2.B).

8. SPECIAL NOTES

Although this system is a highly reliable system, it does not guarantee complete protection against flood. Even the most sophisticated systems can sometimes be defeated or may fail because of:

- A. Incorrect or improperly connected power supply.
- B. The ambient temperature of the protected site is outside the range specified in the SPECIFICATION section.
- C. Even the most reliable electrical systems, including this system, may go wrong because of an unexpected failure of a component part and may cause closing or opening of the water valve(s).
- D. When the electric power fails, it is impossible to close/open the water valve(s).

A protection system should not be regarded as a substitute for insurance. Home and property owners or renters should be prudent enough to continue insuring their lives and property, even though they are protected by the flood protection system.

Due to low transmitting power and limited range (required by FCC and other regulatory authorities), there are some limitations to be considered:

- A. Receivers may be blocked by radio signals occurring on or near their operating frequencies.
- B. Wireless equipment should be tested regularly to determine whether there are sources of interference and to protect against faults.

The user is cautioned that changes or modifications to the unit, not expressly approved by Visonic Ltd., could void the user's FCC authority to operate the equipment.

This device has been designed to comply with the European Council Directive EMC 89/336/EEC & 92/31/EEC and bears the CE mark and certification.

This device has been designed to comply with the limits for a Class B digital device, pursuant to Part 15 of the FCC Rules. These limits are designed to provide reasonable protection against harmful interference in residential installations. This equipment generates uses and can radiate radio frequency energy and, if not installed and used in accordance with the instructions, may cause harmful interference to radio and television reception. However, there is no guarantee that interference will not occur in a particular installation. If this device does cause such interference, which can be verified by turning the device off and on, the user is encouraged to eliminate the interference by one or more of the following measures:

- Re-orient or re-locate the receiving antenna.
- Increase the distance between the device and the receiver.
- Connect the device to an outlet on a circuit different from the one which supplies power to the receiver.
- Consult the dealer or an experienced radio/TV technician.

WARRANTY

Visonic Limited (the "Manufacturer") warrants this product only (the "Product") to the original purchaser only (the "Purchaser") against defective workmanship and materials under normal use of the Product for a period of twelve (12) months from the date of shipment by the Manufacturer.

This Warranty is absolutely conditional upon the Product having been properly installed, maintained and operated under conditions of normal use in accordance with the Manufacturers recommended installation and operation instructions. Products which have become defective for any other reason, according to the Manufacturers discretion, such as improper installation, failure to follow recommended installation and operational instructions, neglect, willful damage, misuse or vandalism, accidental damage, alteration or tampering, or repair by anyone other than the manufacturer, are not covered by this Warranty.

The Manufacturer does not represent that this Product may not be compromised and/or circumvented or that the Product will prevent any death and/or personal injury and/or damage to property resulting from burglary, robbery, fire or otherwise, or that the Product will in all cases provide adequate warning or protection. The Product, properly installed and maintained, only reduces the risk of such events without warning and it is not a guarantee or insurance that such events will not occur.

THIS WARRANTY IS EXCLUSIVE AND EXPRESSLY IN LIEU OF ALL OTHER WARRANTIES, OBLIGATIONS OR LIABILITIES, WHETHER WRITTEN, ORAL, EXPRESS OR IMPLIED, INCLUDING ANY WARRANTY OF MERCHANTABILITY OR FITNESS FOR A PARTICULAR PURPOSE, OR OTHERWISE. IN NO CASE SHALL THE MANUFACTURER BE LIABLE TO ANYONE FOR ANY CONSEQUENTIAL OR INCIDENTAL DAMAGES FOR BREACH OF THIS WARRANTY OR ANY OTHER WARRANTIES WHATSOEVER, AS AFORESAID.

THE MANUFACTURER SHALL IN NO EVENT BE LIABLE FOR ANY SPECIAL, INDIRECT, INCIDENTAL, CONSEQUENTIAL OR PUNITIVE DAMAGES OR FOR LOSS, DAMAGE, OR EXPENSE, INCLUDING LOSS OF USE, PROFITS, REVENUE, OR GOODWILL, DIRECTLY OR INDIRECTLY ARISING FROM PURCHASER'S USE OR INABILITY TO USE THE PRODUCT, OR FOR LOSS OR DESTRUCTION OF OTHER PROPERTY OR FROM ANY OTHER CAUSE, EVEN IF MANUFACTURER HAS BEEN ADVISED OF THE POSSIBILITY OF SUCH DAMAGE.

THE MANUFACTURER SHALL HAVE NO LIABILITY FOR ANY DEATH, PERSONAL AND/OR BODILY INJURY AND/OR DAMAGE TO PROPERTY OR OTHER LOSS WHETHER DIRECT, INDIRECT, INCIDENTAL, CONSEQUENTIAL OR OTHERWISE, BASED ON A CLAIM THAT THE PRODUCT FAILED TO FUNCTION.

However, if the Manufacturer is held liable, whether directly or indirectly, for any loss or damage arising under this limited warranty, the Manufacturer's maximum liability (if any) shall not in any case exceed the purchase price of the Product, which shall be fixed as liquidated damages and not as a penalty, and shall be the complete and exclusive remedy against the Manufacturer.

When accepting the delivery of the Product, the Purchaser agrees to the said conditions of sale and warranty and he recognizes having been informed of.

Some jurisdictions do not allow the exclusion or limitation of incidental or consequential damages, so these limitations may not apply under certain circumstances.

The Manufacturer shall be under no liability whatsoever arising out of the corruption and/or malfunctioning of any telecommunication or electronic equipment or any programs.

The Manufacturers obligations under this Warranty are limited solely to repair and/or replace at the Manufacturer's discretion any Product or part thereof that may prove defective. Any repair and/or replacement shall not extend the original Warranty period. The Manufacturer shall not be responsible for dismantling and/or reinstallation costs. To exercise this Warranty the Product must be returned to the Manufacturer freight pre-paid and insured. All freight and insurance costs are the responsibility of the Purchaser and are not included in this Warranty.

This warranty shall not be modified, varied or extended, and the Manufacturer does not authorize any person to act on its behalf in the modification, variation or extension of this warranty. This warranty shall apply to the Product only. All products, accessories or attachments of others used in conjunction with the Product, including batteries, shall be covered solely by their own warranty, if any. The Manufacturer shall not be liable for any damage or loss whatsoever, whether directly, indirectly, incidentally, consequentially or otherwise, caused by the malfunction of the Product due to products, accessories, or attachments of others, including batteries, used in conjunction with the Products. This Warranty is exclusive to the original Purchaser and is not assignable.

This Warranty is in addition to and does not affect your legal rights. Any provision in this warranty which is contrary to the Law in the state or country where the Product is supplied shall not apply.

Warning: The user must follow the Manufacturer's installation and operational instructions including testing the Product and its whole system at least once a week and to take all necessary precautions for his/her safety and the protection of his/her property.

1/08



W.E.E. Product Recycling Declaration

For information regarding the recycling of this product you must contact the company from which you originally purchased it. If you are discarding this product and not returning it for repair then you must ensure that it is returned as identified by your supplier. This product is not to be thrown away with everyday waste. Directive 2002/96/EC Waste Electrical and Electronic Equipment.



VISONIC LTD. (ISRAEL): P.O.B 22020 TEL-AVIV 61220 ISRAEL. PHONE: (972-3) 645-6789, FAX: (972-3) 645-6788

VISONIC INC. (U.S.A.): 65 WEST DUDLEY TOWN ROAD, BLOOMFIELD CT. 06002-1376. PHONE: (860) 243-0833, (800) 223-0020. FAX: (860) 242-8094

VISONIC LTD. (UK): 7 COPPERHOUSE COURT, CALDECOTTE, MILTON KEYNES. MK7 8NL. PHONE: (0870) 7300800 FAX: (0870) 7300801

PRODUCT SUPPORT (0870) 7300830

INTERNET: www.visonic.com

©VISONIC LTD. 2008 MCW-570 Installation Instructions D-300767 (REV. 4, 11/08)



MADE IN ISRAEL