

# NEXT<sup>®</sup> K9-85 MCW

Wireless PowerCode Pet-Immune PIR Detector



## Installation Instructions

### 1. INTRODUCTION

The NEXT K9-85 MCW is a pet-immune microprocessor-controlled wireless digital PIR detector, designed for easy installation, free of vertical adjustment. It features a cylindrical lens with uniform detection sensitivity throughout its operating range, up to 12 meters (40 ft), with immunity to pets weighing up to 38 kg (85 lb).

NEXT is a registered mark of Visonic Ltd.

The advanced **True Motion Recognition™** algorithm (patented) allows the NEXT K9-85 MCW to distinguish between the true motion of an intruder and any other disturbances which may cause false alarms. In addition, **Target Specific Imaging™ (TSI)** technology is employed for distinction between human beings and pets.

An on-board motion event jumper determines whether 1 or 2 consecutive motion events trigger an alarm.

The NEXT K9-85 MCW includes the following features:

- Incorporates a fully supervised PowerCode transmitter
- Patented sophisticated motion analysis algorithm - True Motion Recognition (TMR™)
- Sophisticated frequency domain digital signal processing
- No vertical adjustment is needed
- Programmable motion event counter
- After detection, the detector disarms itself to save battery power. It rearms (reverts to the ready state) if there is no subsequent detection throughout the following 2-minute period.
- An optional version provides better protection for systems compliant with DD243. After initial detection, the detector is capable of 7 additional detections for a period of 5 minutes. Further detection is possible only if no movement occurs during the following 2 minutes. The detector will revert to the initial state if there is no movement for an additional 5 minutes.

- Very low current consumption
- Microprocessor-controlled temperature compensation
- Sealed chamber protects the optical system
- Front cover tamper switch
- Back tamper switch (option)
- White light protection
- Elegantly styled, sturdy case

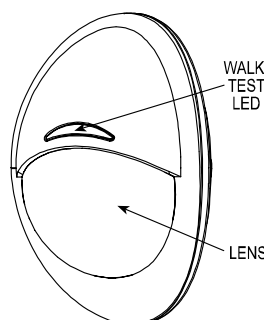

Figure 1. General View

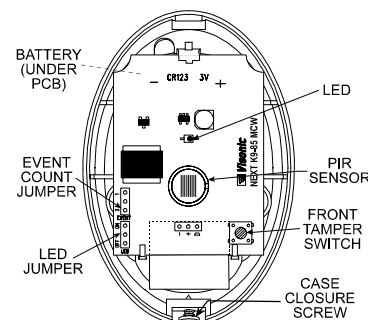

Figure 2. Inside View

#### For UL installations:

- The detector is for use with UL listed control unit PowerMax+ only.
- Pet immunity has not been evaluated by UL.

### 2. SPECIFICATIONS

#### OPTICAL

**Detector Type:** Dual element low-noise pyroelectric sensor.

#### Lens Data

**No. of Curtain Beams:** 9  
**Max. Coverage:** 12 x 12 m (40 x 40 ft) / 90°

**Pet Immunity:** Up to 38 kg (85 lb).

#### ELECTRICAL

**Internal Battery:** 3V Lithium battery, type CR-123A. For UL installations, use Panasonic or Sanyo only.

**Nominal Battery Capacity:** 1450 mA/h.

**Standby Current Drain:** approx. 0.025 mA.

**Transmit Current Drain:** 20 mA (including LED).

**Battery Life (with LED on):** Typically over 3 years.

**Battery Power Test:** Performed immediately upon battery insertion and periodically after every several hours.

#### FUNCTIONAL

**True Motion Event Verification:** 2 position selector - 1 (OFF) or 2 (ON) motion events.

**Alarm Period:** 3 seconds.

#### Visual Indications:

**LED Lights** for about 3 seconds upon transmission of alarm & tamper messages and upon motion detection in the walk test mode.

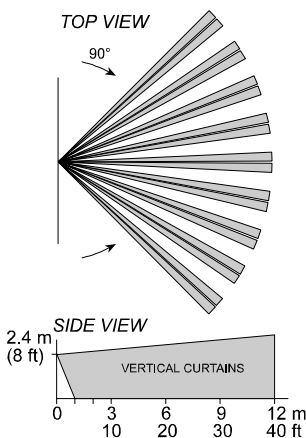

Figure 3. Coverage Pattern

**LED Flashes** during the power-up stabilization period, or after restoring (pressing) the tamper switch.

**LED Does not light** upon transmission of supervision messages.

**Rearm Timer:** Rearms the detector 2 minutes after the last alarm. Timer disabled in the walk test mode – not applicable for the DD243 version (see section 1).

#### WIRELESS

**Frequency (MHz):** 315 (U.S. version), 433.92, 868.95, 869.2625 or other frequencies according to local requirements.

**Transmission Sequence:** 3 data bursts at variable intervals within 3 seconds.

**Encoding:** 24-bit ID, over 16 million possible combinations.

**Total Message Length:** 36 bits.

**Tamper Alert:** Reported when a tamper event occurs and in any subsequent message, until the tamper switch is restored.

**Supervision Message:** Signaling at 60 minutes interval (U.S. version), 15 minute interval (UK version) or according to local standards.

#### MOUNTING

**Height:** 1.8 - 2.4 m (6 - 8 ft). Recommended height up to 2.1 m (7 ft)

**Installation Options:** Surface or corner.

#### ACCESSORIES:

**BR-1:** Surface mounted swivel bracket, adjustable 30° down and 45° left/45° right.

**BR-2:** BR-1 with a corner adapter

**BR-3:** BR-1 with a ceiling adapter

## ENVIRONMENTAL

**RFI Protection:** >20 V/m up to 1000 MHz.

**Operating Temperatures:** -10°C to 50°C (14°F to 122°F).

**Storage Temperatures:** -20°C to 60°C (-4°F to 140°F).

**Compliance with Standards:** Designed to meet FCC Part 15 and Directive 1999/5/EC of the European Parliament.

## PHYSICAL

**Size (H x W x D):** 94.5 x 63.5 x 53.0 mm (3-11/16 x 2-1/2 x 2-1/16").

**Weight (with battery):** 70 g (2.5 oz).

**Color:** White.

**PATENTS:** U.S. Patents 5,693,943 • 6,211,522 • D445,709 (another patent pending).

## 3. INSTALLATION

### 3.1 General Guidelines

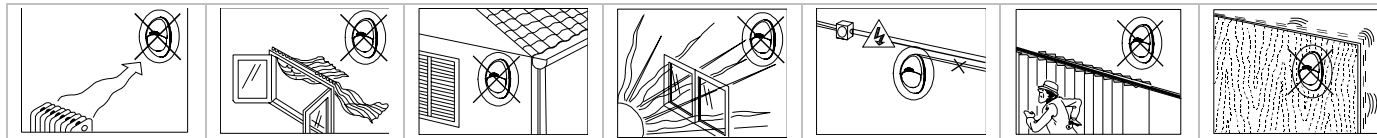

### 3.2 Illustrated Installation Procedure

#### 1 Disassemble the unit

**C** SHIFT COVER UP TO FREE TOP TOOTH AND REMOVE COVER

**E** PULL OUT LOWER EDGE OF COVER

**D** FLEX CATCH OUT

**A** LOOSEN SCREW

**B** REMOVE BOARD

#### 2 Install the battery

**A** **RESET:** With the battery in place, press both tamper switches simultaneously and release them. The LED at the front will flash for about 2 minutes until the detector stabilizes. *Note: The detector transmits a low battery signal upon detection of low battery.* *Note: It is recommended to wait about 1 minute before inserting the new battery.*

**B** **ENROLL:** Approach the control panel and enroll the detector's ID into the control panel's memory as shown in the panel's installation manual. When required to transmit, press both tamper switches again and release them. You may enroll the detector's ID while the detector's LED flashes.

**OBSERVE POLARITY!**

FRONT TAMPER SWITCH

BACK TAMPER SWITCH (OPTION)

#### 3 Open holes in the base

**A** USE A SCREWDRIVER TO PIERCE SURFACE OR CORNER KNOCK-OUTS, AS REQUIRED.

**B** USE A LARGE DIAMETER DRILL BIT TO DE-BURR THE OTHER SIDE

TOP CATCH FOR PCB

CORNER (2 OF 4)

SURFACE (1 OF 2)

SUPPORTS FOR BOTTOM EDGE OF PCB

BREAK-AWAY SEGMENT (BACK TAMPER SWITCH ACTUATOR - OPTION)

**Attention!** Lean the rear part of the break-away segment against a piece of wood while piercing its knockouts.

#### 4 Mount the base

1.8 - 2.4 m (6 - 8 ft) above ground  
Recommended height up to 2.1 m (7 ft)

**A** FOR TAMPER PROTECTION, THE BREAK-AWAY SEGMENT MUST BE ATTACHED TO WALL.

**B** MARK TWO DRILLING POINTS AND DRILL HOLES IN WALL.

**C** INSERT TWO DOWELS AND ATTACH THE BASE TO THE WALL WITH TWO SCREWS.

**D** INSERT THE BOTTOM EDGE OF THE LARGE P.C. BOARD UNDER THE TABS & PRESS THE TOP EDGE IN.

**Attention!** The unit has a back tamper switch (option) under the PCB. As long as the PCB is seated firmly within the base, the switch will be pressed against a metal spring piece attached to the base. **Be sure to fasten the break-away segment to the wall with the screws going through the metal spring and break-away base segment.** If the detector is forcibly removed from the wall, this segment will break away from the base, causing the tamper switch to open and send a tamper alarm.

SINGLE-SIDE, 45° ANGLED MOUNT

SINGLE-SIDE, 45° ANGLED MOUNT

BREAK-AWAY SEGMENT

SURFACE MOUNT (1 OF 2)

## 5 Set the jumpers as needed

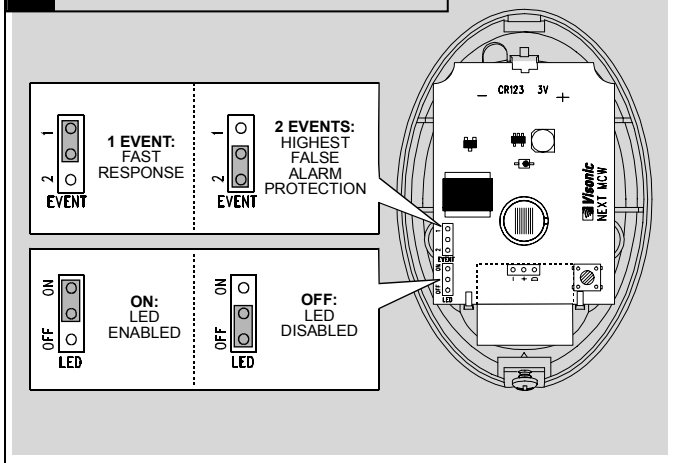

## 6 Walk-test the coverage area

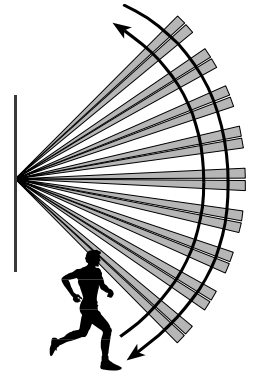
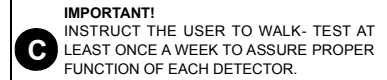
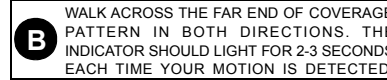
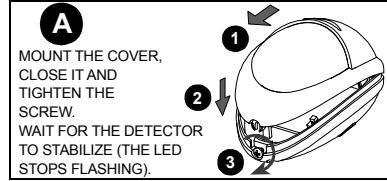

**Note:** After closing the cover the detector enters a 15 minute walk-test mode. In this mode the LED will flash each time a detection occurs, regardless of LED jumper settings, and the detector will transmit on the occurrence of each event.

## LED Functions Summary

LED Jumper Position	First 2-3 Minutes After Closing Cover	Within 15 Minutes After Closing Cover - "Walk Test Mode"	More than 15 Minutes After Closing Cover - "Normal Mode"
ON	LED Flashes	LED lights and the unit sends RF alarm signal on every detection	LED lights, the unit sends RF alarm signal and enters 2 minutes sleep mode.
OFF	LED Flashes	LED lights and the unit sends RF alarm signal on every detection	LED does not light! Unit sends RF alarm signal and enters 2 minutes sleep mode.



**Important!** The detector is immune to 38 kg (85 lb) animals moving on the floor or climbing on furniture as long as the activity takes place below 1 m (3 ft). Above the 1 m (3 ft) height limit, the detector is immune to 19 kg (42 lb) pets, but the pet immunity will decrease as the pet gets closer to the detector. It is therefore recommended to select a mounting location that minimizes potential close proximity of animals.



### Correct use of the optional brackets:

**With pets:** in pet immune applications, optional brackets should be used for horizontal alignment only - the detector should remain vertical (perpendicular to the ground).

**Without pets:** To obtain the best possible coverage where no pets are present, use a bracket and tilt the detector 20° down.

## 4. SPECIAL COMMENTS

### 4.1 Product Limitations

Visonic Ltd. wireless systems are very reliable and are tested to high standards. However, due to their low transmitting power and limited range (required by FCC and other regulatory authorities), there are some limitations to be considered:

- Receivers may be blocked by radio signals on or near their operating frequencies, regardless of the code selected.
- A receiver can only respond to one signal at a time.
- Wireless equipment should be tested regularly to determine whether there are sources of interference and to protect against faults.
- Even the most sophisticated detectors can sometimes be defeated or may fail to warn due to: DC power failure / improper connection, malicious masking of the lens, tampering with the optical system, decreased sensitivity in ambient temperatures near that of the human body and unexpected failure of a component part.

The above list includes the most common reasons for failure to detect intrusion, but is by no means comprehensive. It is therefore recommended that the detector and the entire alarm system be checked weekly, to ensure proper performance.

- An alarm system should not be regarded as a substitute for insurance. Home and property owners or renters should be prudent enough to continue insuring their lives and property, even though they are protected by an alarm system.

### 4.2 Compliance with Standards

The 315 MHz version of this device complies with Part 15 of the FCC Rules. Operation is subject to the following two conditions: (1) This device may not cause harmful interference, and (2) This device must accept any interference received, including interference that may cause undesired operation.

**WARNING! Changes or modifications to this unit not expressly approved by the party responsible for compliance could void the user's authority to operate the equipment.**

The digital circuit of this device has been tested and found to comply with the limits for a Class B digital device, pursuant to Part 15 of the FCC Rules. These limits are designed to provide reasonable protection against harmful interference in residential installations. This equipment generates, uses and can radiate radio frequency energy and, if not installed and used in accordance with the instructions, may cause harmful interference to radio and television reception. However, there is no guarantee that interference will not occur in a particular installation. If this device does cause such interference, which can be verified by turning the device off and on, the user is encouraged to eliminate the interference by one or more of the following measures:

- Re-orient or re-locate the receiving antenna.
- Increase the distance between the device and the receiver.
- Connect the device to an outlet on a circuit different from the one which supplies power to the receiver.
- Consult the dealer or an experienced radio/TV technician.

### 4.3 Frequency Allocations for Wireless Devices in European (EU) Countries

- 315 MHz is not allowed in any EU member state.
- 433.92 MHz has no restriction in any EU member state.
- 868.95 MHz (wide band) is allowed in all EU member states.
- 869.2625 MHz (narrow band) is not restricted in any EU member state.

### 4.4 Battery Handling

- A. Replace battery ONLY with recommended battery (see specifications).
- B. Dispose used batteries according to their manufacturer's instructions.

#### WARRANTY

Visonic Ltd. and/or its subsidiaries and its affiliates ("the Manufacturer") warrants its products hereinafter referred to as "the Product" or "Products" to be in conformance with its own plans and specifications and to be free of defects in materials and workmanship under normal use and service for a period of twelve months from the date of shipment by the Manufacturer. The Manufacturer's obligations shall be limited within the warranty period, at its option, to repair or replace the product or any part thereof. The Manufacturer shall not be responsible for dismantling and/or reinstallation charges. To exercise the warranty the product must be returned to the Manufacturer freight prepaid and insured.

**This warranty does not apply in the following cases:** improper installation, misuse, failure to follow installation and operating instructions, alteration, abuse, accident or tampering, and repair by anyone other than the Manufacturer.

This warranty is exclusive and expressly in lieu of all other warranties, obligations or liabilities, whether written, oral, express or implied, including any warranty of merchantability or fitness for a particular purpose, or otherwise. In no case shall the Manufacturer be liable to anyone for any consequential or incidental damages for breach of this warranty or any other warranties whatsoever, as aforesaid.

This warranty shall not be modified, varied or extended, and the Manufacturer does not authorize any person to act on its behalf in the modification, variation or extension of this warranty. This warranty shall apply to the Product only. All products, accessories or attachments of others used in conjunction with the Product, including batteries, shall be covered solely by their own warranty, if any. The Manufacturer shall not be liable for any damage or loss whatsoever, whether directly, indirectly, incidentally, consequentially or otherwise, caused by the malfunction of the Product due to products, accessories, or attachments of others, including batteries, used in conjunction with the Products.

The Manufacturer does not represent that its Product may not be compromised and/or circumvented, or that the Product will prevent any death, personal and/or bodily injury and/or damage to property resulting from burglary, robbery, fire or otherwise, or that the Product will in all cases provide adequate warning or protection. User understands that a properly installed and maintained alarm may only reduce the risk of events such as burglary, robbery, and fire without warning, but it is not insurance or a guarantee that such will not occur or that there will be no death, personal damage and/or damage to property as a result.

**The Manufacturer shall have no liability for any death, personal and/or bodily injury and/or damage to property or other loss whether direct, indirect, incidental, consequential or otherwise, based on a claim that the Product failed to function.** However, if the Manufacturer is held liable, whether directly or indirectly, for any loss or damage arising under this limited warranty or otherwise, regardless of cause or origin, the Manufacturer's maximum liability shall not in any case exceed the purchase price of the Product, which shall be fixed as liquidated damages and not as a penalty, and shall be the complete and exclusive remedy against the Manufacturer.

**Warning:** The user should follow the installation and operation instructions and among other things test the Product and the whole system at least once a week. For various reasons, including, but not limited to, changes in environmental conditions, electric or electronic disruptions and tampering, the Product may not perform as expected. The user is advised to take all necessary precautions for his/her safety and the protection of his/her property.

6/91



VISONIC LTD. (ISRAEL): P.O.B 22020 TEL-AVIV 61220 ISRAEL. PHONE: (972-3) 645-6789, FAX: (972-3) 645-6788  
VISONIC INC. (U.S.A.): 10 NORTHWOOD DRIVE, BLOOMFIELD CT. 06002-1911. PHONE: (860) 243-0833, (800) 223-0020 FAX: (860) 242-8094  
VISONIC LTD. (UK): FRASER ROAD, PRIORY BUSINESS PARK, BEDFORD MK44 3WH. PHONE: (0870) 730-0800 FAX: (0870) 730-0801  
INTERNET: www.visonic.com

©VISONIC LTD. 2004 NEXT K9-85 MCW DE3592- (REV. 4, 1/04)



MADE IN ISRAEL

DE3592